

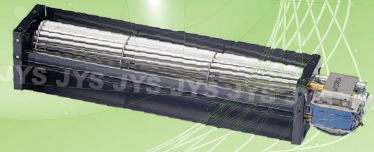

# CROSS FLOW FAN

JIN YIH SHYANG ENTERPRISE CO., LTD.



Single Blower



Double Blower



Triple Blower



Air Curtain



# JVD-025A SERIES DC FAN

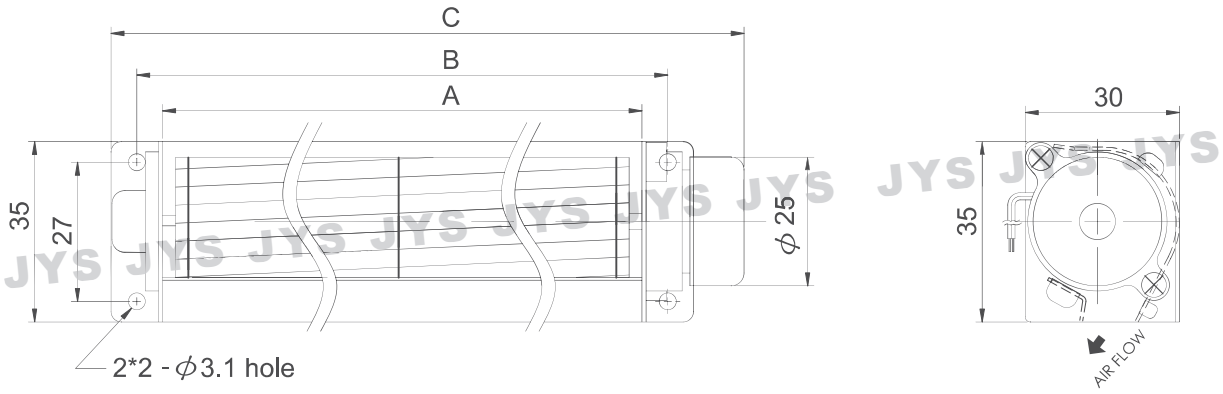

Motor type: DC Brushless type

Spec. Model	Size (mm)			Rated Voltage (V)	Rated Current (A)	Speed (r.p.m.)	Max Pressure (mmAq)	Maximum Air Flow (m <sup>3</sup> /min)	CFM	Noise (dBA)	Safety Approval			Weight (g)
	A	B	C								UL	TUV	CE	
JVD-02509A12	98	108	129	12	0.13	4000	1.8	0.25	9	30	○		○	80
JVD-02515A12	160	170	191	12	0.13	3400	1.0	0.35	12	31	○		○	100
JVD-02519A12	198	208	229	12	0.13	3300	1.0	0.43	15	35	○		○	110

JVD-02509A

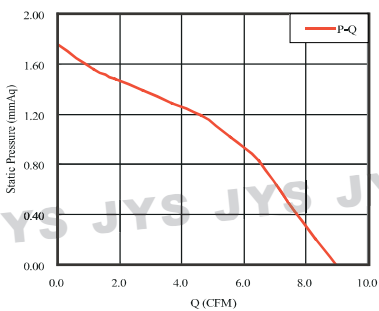

JVD-02515A

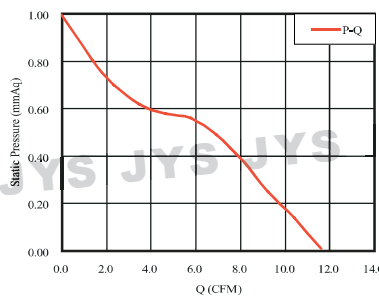

JVD-02519A

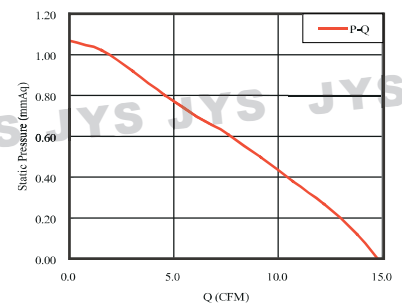



# JED-030A/JF3-030A SERIES DC FAN



(Single Blower)

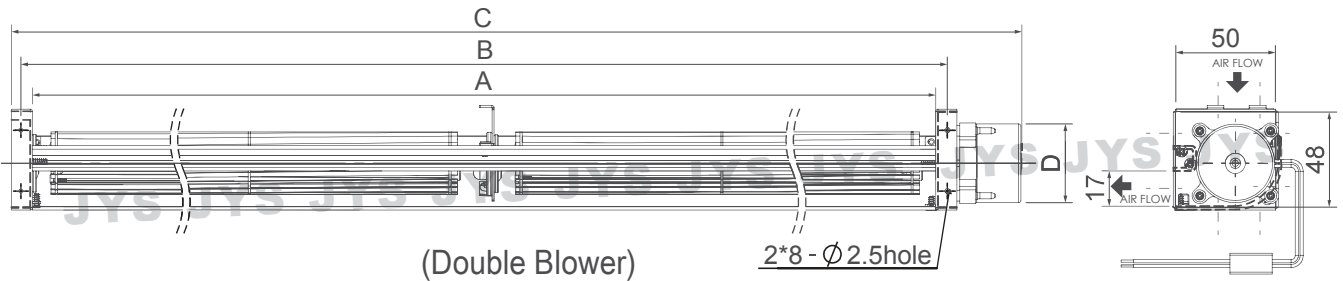

(Double Blower)

Motor :DC Brushless type

※ ○ : Single Blower ◎ : Double Blower

Model	Spec.	Size(mm)				Rated Voltage (DC V)	Rated Current (A)	Speed (r.p.m.)	Max Pressure (mmAq)	Maximun Air Flow (m <sup>3</sup> /min)	Noise dB(A)	Weight (g)	Safety Approval			Blower
		A	B	C	D								UL	TUV	CE	
JED-03009A12-3B	①	98	108	134	31	12	0.15	3200	1.9	0.6	29	180	○		○	○
JED-03009A24-3B	①					24	0.18						○		○	○
JED-03015A12-3B	②	160	170	196	31	12	0.16	3100	1.7	0.8	30	210	○		○	○
JED-03015A24-3B	②					24	0.15						○		○	○
JED-03019A12-3B	③	198	208	234	31	12	0.20	2900	1.7	1.0	31	230	○		○	○
JED-03019A24-3B	③					24	0.16								○	○
JED-03029A12-3B	④	300	310	336	31	12	0.22	2600	1.5	1.3	33	290	○		○	○
JED-03029A24-3B	④					24	0.20								○	○
JF3-3030X2A24Q-4B	⑤	630	640	680	38	24	0.22	2850	1.8	3.2	36	580			○	◎
JF3-3035X2A24Q-4B	⑥	730	740	780	38		0.25	2750	1.7	3.9	35	630			○	◎
JF3-3040X2A24Q-4B	⑦	830	840	880	38		0.28	2650	1.6	4.2	34	690			○	◎

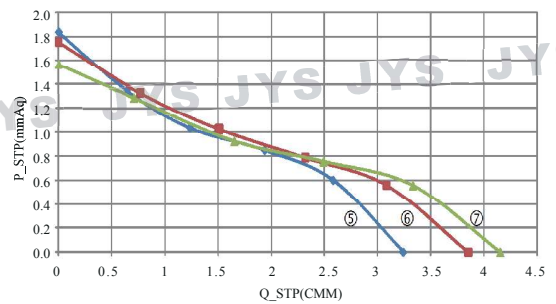
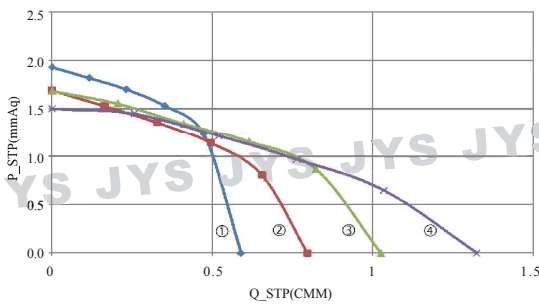

# JED-040/JE3-040/JF3-040A SERIES DC FAN



(Single Blower)

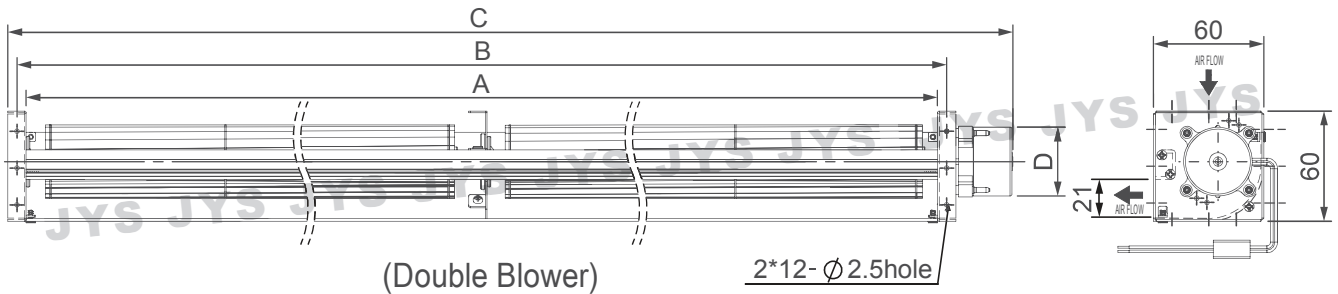

(Double Blower)

2\*12- Ø2.5hole

Motor :DC Brushless type

※ ○ : Single Blower ◎ : Double Blower

Model	Spec.	Size(mm)				Rated Voltage (DC V)	Rated Current (A)	Speed (r.p.m.)	Max Pressure (mmAq)	Maximum Air Flow (m <sup>3</sup> /min)	Noise dB(A)	Weight (g)	Safety Approval			※ Blower
		A	B	C	D								UL	TUV	CE	
JED-04009A12-3B	①	98	108	144	31	12	0.20	3000	2.9	0.7	33	220			○	○
JED-04009A24-3B	①					24	0.15								○	○
JED-04015A12-3B	②	160	170	206	31	12	0.25	2600	2.6	1.0	31	260			○	○
JED-04015A24-3B	②					24	0.20								○	○
JED-04019A12Q-3B	③	198	208	246	38	12	0.30	2500	2.5	1.4	33	310			○	○
JED-04019A24Q-3B	③					24	0.20								○	○
JED-04029A12Q-3B	④	300	310	348	38	12	0.40	2300	2.0	2.1	33	410			○	○
JED-04029A24Q-3B	④					24	0.20								○	○
JE3-04030A24-3B	⑤	310	320	350	38	24	0.30	2600	3.0	2.7	39	420			○	○
JE3-04035A24-3B	⑥	360	370	400	38		0.32	2450	2.6	3.0	38	470			○	○
JE3-04040A24-3B	⑦	410	420	450	38		0.34	2300	2.5	3.5	37	510			○	○
JF3-4030X2A24-3B	⑧	630	640	660	38		0.26	1800	1.4	3.7	39	690			○	◎
JF3-4035X2A24-3B	⑨	730	740	760	38		0.27	1750	1.4	4.2	38	770			○	◎
JF3-4040X2A24-3B	⑩	830	840	860	38		0.28	1600	1.3	4.6	37	830			○	◎

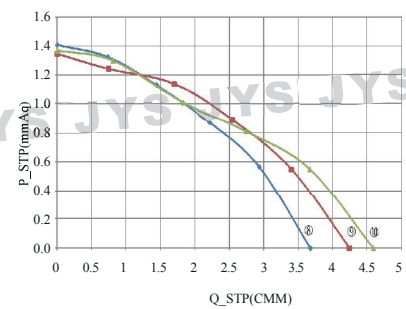
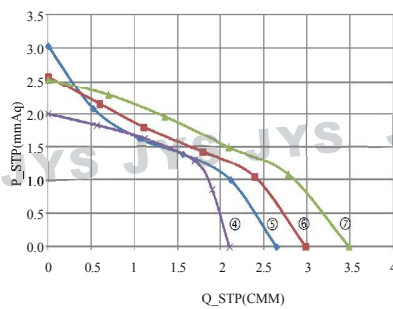
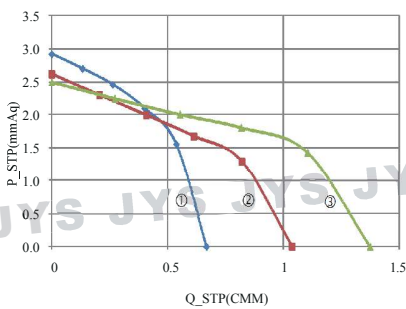





# JED-043/JE3-043A SERIES DC FAN

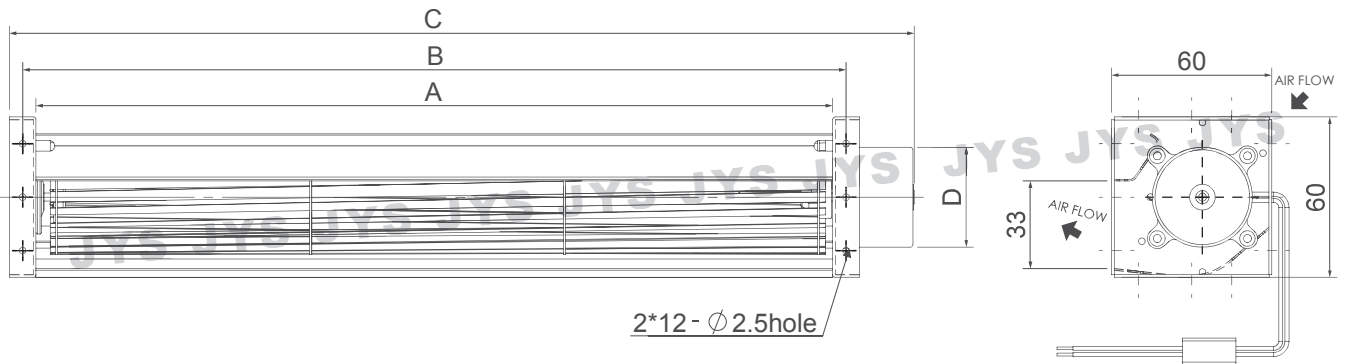

Motor :DC Brushless type

Model	Spec.	Size(mm)				Rated Voltage (DC V)	Rated Current (A)	Speed (r.p.m.)	Max Pressure (mmAq)	Maximum Air Flow (m <sup>3</sup> /min)	Noise dB(A)	Weight (g)	Safety Approval		
		A	B	C	D								UL	TUV	CE
JED-04309A12-3B	①	98	108	144	31	12	0.22	2800	1.8	0.7	36	220			
JED-04309A24-3B	①					24	0.18								
JED-04315A12Q-3B	②	160	170	208	38	12	0.35	2500	1.2	1.2	37	270			
JED-04315A24Q-3B	②					24	0.20								
JED-04319A12Q-3B	③	198	208	246	38	12	0.35	2400	1.0	1.5	39	310			
JED-04319A24Q-3B	③					24	0.20								
JED-04324A12Q-3B	④	250	260	298	38	12	0.42	2200	0.7	1.7	34	350			
JED-04324A24Q-3B	④					24	0.22								
JE3-04329A24-3B	⑤	300	310	340	38	24	0.33	2500	1.9	2.5	37	420			○
JE3-04335A24-3B	⑥	360	370	400	38		0.35	2400	1.6	2.8	37	440			○

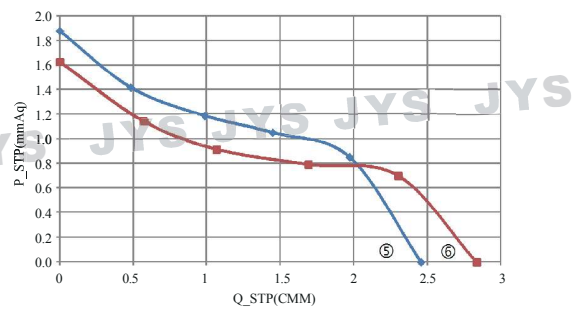
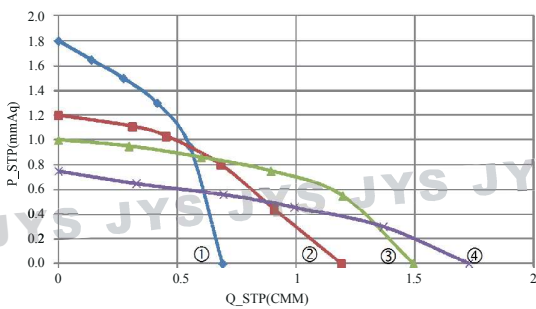

## JQ3-043A SERIES DC FAN

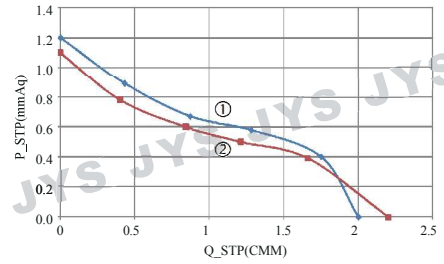

Motor :DC Brushless type(3Phase)

Model	Spec.	Size(mm)			Rated Voltage (DC V)	Rated Current (A)	Speed (r.p.m.)	Max Pressure (mmAq)	Maximum Air Flow (m <sup>3</sup> /min)	Noise dB(A)	Weight (g)
		A	B	C							
JQ3-04325A24-3B	①	250	260	297	24	0.26	2500	1.2	2.0	36	340
JQ3-04329A24-3B	②	290	300	337		0.25	2700	1.1	2.2	38	370

## JQ3-045A SERIES DC FAN

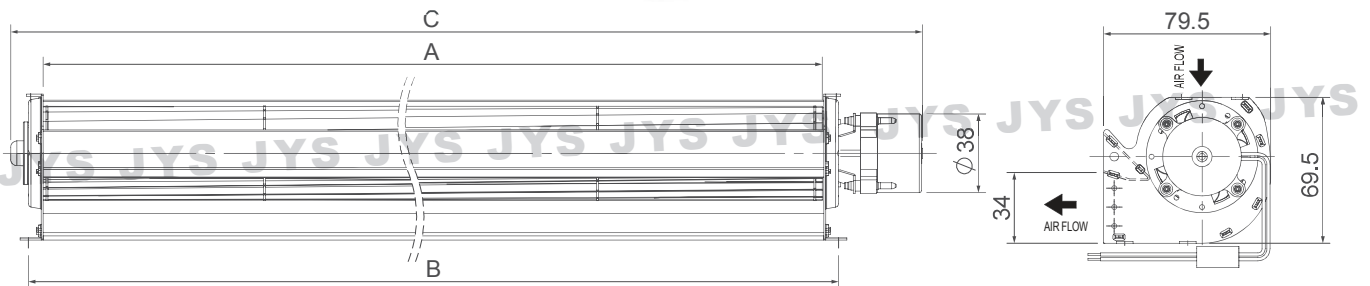
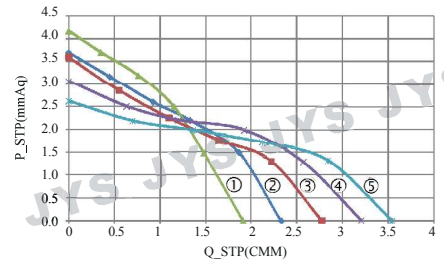

Motor :DC Brushless type(3Phase)

Model	Spec.	Size(mm)			Rated Voltage (DC V)	Rated Current (A)	Speed (r.p.m.)	Max Pressure (mmAq)	Maximum Air Flow (m <sup>3</sup> /min)	Noise dB(A)	Weight (g)
		A	B	C							
JQ3-04518A24Q-3B	①	180	194	250	24	0.23	2000	4.1	1.9	46	450
JQ3-04524A24Q-3B	②	240	254	300		0.24	1800	3.7	2.3	45	530
JQ3-04530A24Q-3B	③	300	314	360		0.27	1700	3.6	2.7	44	610
JQ3-04536A24Q-3B	④	360	374	430		0.29	1600	3.1	3.2	43	690
JQ3-04542A24Q-3B	⑤	420	434	490		0.30	1500	2.6	3.6	42	770



# CROSS FLOW FAN

## JF3-045A SERIES(Double Blower) DC FAN

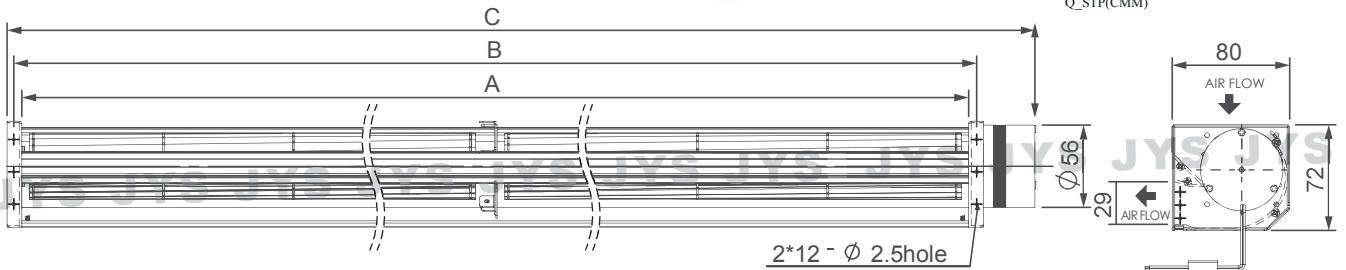
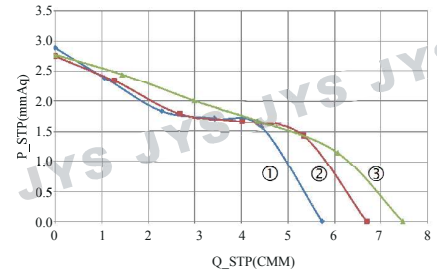

Motor :DC Brushless type(3Phase)

Model	Spec.	Size(mm)			Rated Voltage (DC V)	Rated Current (A)	Speed (r.p.m.)	Max Pressure (mmAq)	Maximun Air Flow (m <sup>3</sup> /min)	Noise dB(A)	Weight (kg)
		A	B	C							
JF3-4530X2A24-3B	①	630	640	685	24	0.55	1950	2.9	5.7	46	1.10
JF3-4536X2A24-3B	②	750	760	805		0.59	1850	2.8	6.7	45	1.25
JF3-4542X2A24-3B	③	870	880	925		0.63	1800	2.8	7.5	45	1.35

## JM3-050A SERIES DC FAN

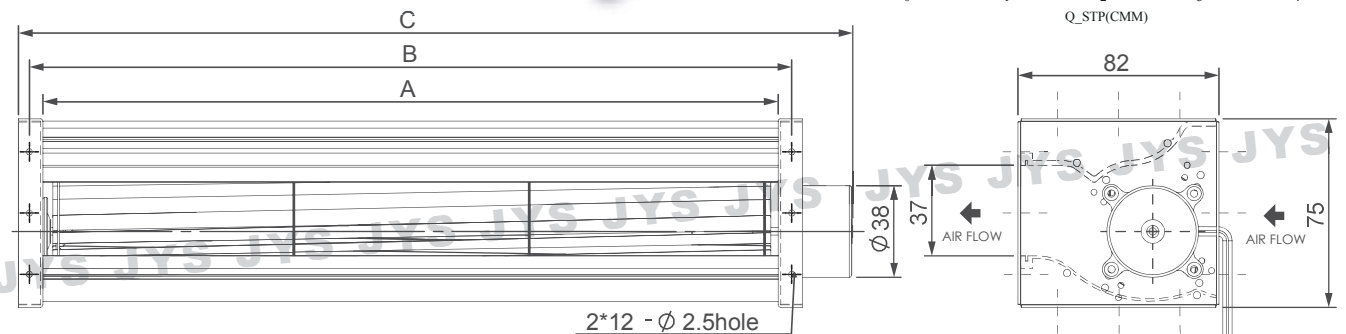
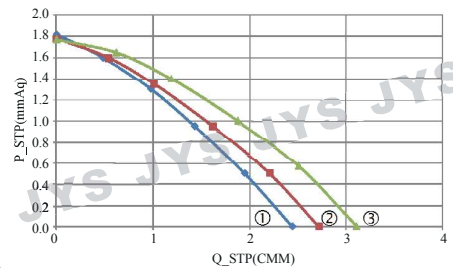

Motor :DC Brushless type(3Phase)

Model	Spec.	Size(mm)			Rated Voltage (DC V)	Rated Current (A)	Speed (r.p.m.)	Max Pressure (mmAq)	Maximun Air Flow (m <sup>3</sup> /min)	Noise dB(A)	Weight (g)
		A	B	C							
JM3-05029A24-3B	①	300	310	340	24	0.29	2700	1.8	2.5	37	600
JM3-05035A24-3B	②	360	370	400		0.30	2600	1.8	2.7	38	660
JM3-05042A24-3B	③	430	440	470		0.32	2500	1.7	3.1	39	730

# JE3-050/JF3-050A SERIES DC FAN



(Single Blower)

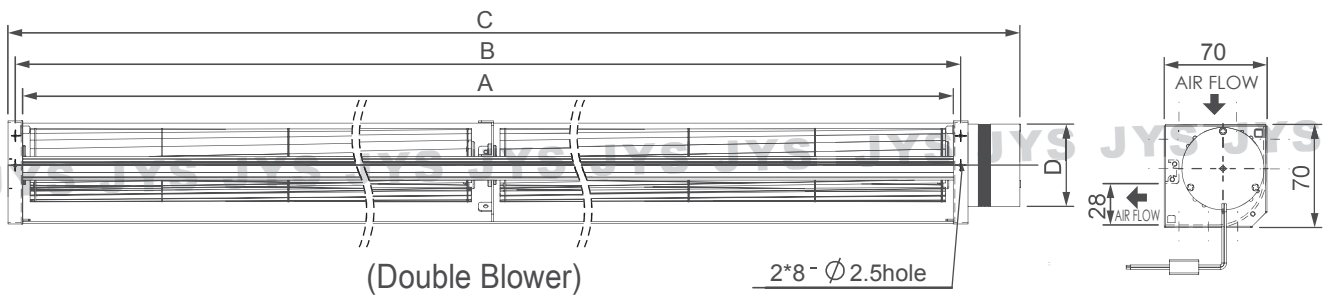

(Double Blower)

Motor :DC Brushless type(3Phase)

※ ○ : Single Blower ◎ : Double Blower

Model	Spec.	Size(mm)				Rated Voltage (DC V)	Rated Current (A)	Speed (r.p.m.)	Max Pressure (mmAq)	Maximun Air Flow (m <sup>3</sup> /min)	Noise dB(A)	Weight (g)	Blower
		A	B	C	D								
JE3-05009A24-3B	①	98	108	148	38	24	0.13	2600	5.9	1.3	37	370	○
JE3-05019A24-3B	②	198	208	248	38		0.31	2500	4.7	2.5	43	470	○
JE3-05029A24-3B	③	298	308	348	38		0.35	2200	4.3	3.5	44	590	○
JE3-05035A24-3B	④	358	368	408	38		0.26	1800	3.7	3.8	36	660	○
JE3-05042A24-3B	⑤	428	438	478	38		0.27	1700	3.3	4.2	35	730	○
JF3-5029X2A24-3B	⑥	610	620	665	56		0.45	2050	2.1	5.5	40	1030	◎
JF3-5035X2A24-3B	⑦	730	740	785	56		0.47	2000	2.4	6.6	40	1140	◎
JF3-5042X2A24-3B	⑧	870	880	925	56		0.53	1950	1.9	7.4	39	1250	◎

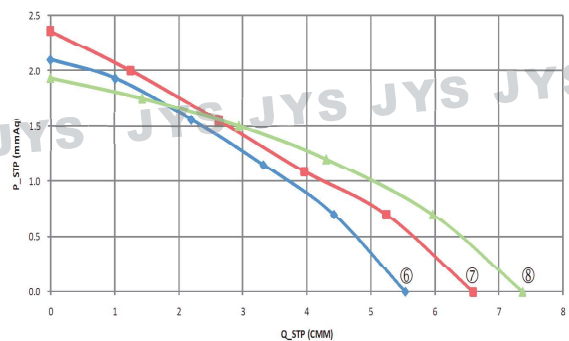
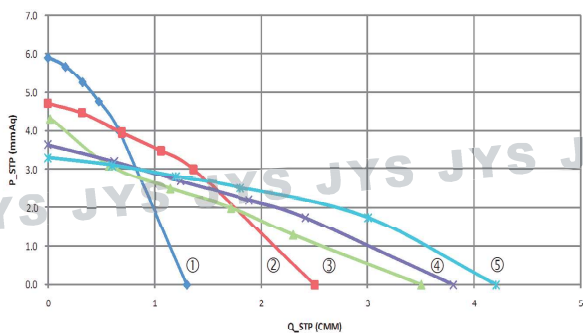



### JH3-060A SERIES DC FAN

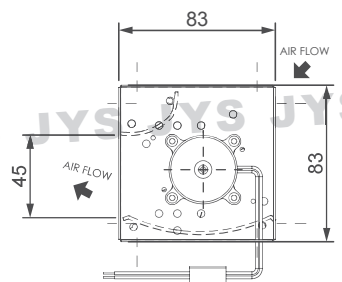
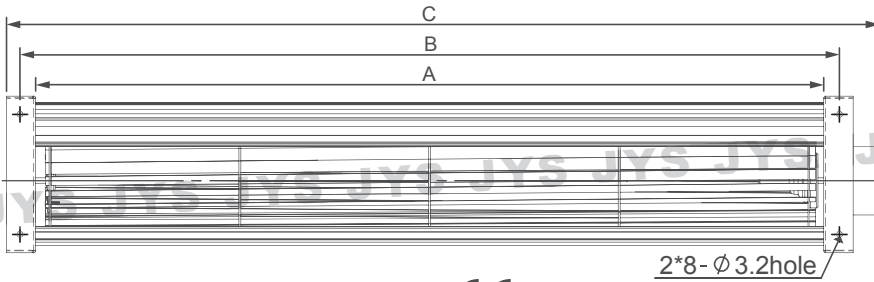
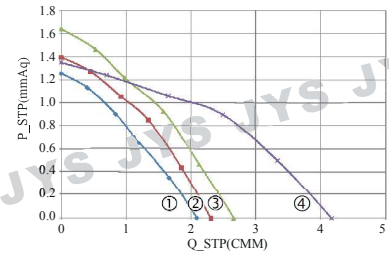

Motor :DC Brushless type(3Phase) **CE**

Model	Spec.	Size(mm)				Rated Voltage (DC V)	Rated Current (A)	Speed (r.p.m.)	Max Pressure (mmAq)	Maximun Air Flow (m³/min)	Noise dB(A)	Weight (g)
		A	B	C	D							
JH3-06030A24-3B	①	306	321	351	38	24	0.26	1900	1.3	2.1	35	680
JH3-06036A24-3B	②	366	381	411	38		0.28	1700	1.4	2.3	34	740
JH3-06042A24-3B	③	426	441	471	38		0.29	1600	1.6	2.7	33	810
JH3-06060A24-3B	④	606	621	664	56		0.57	1900	1.4	4.2	36	1260

### JM3-060A SERIES DC FAN

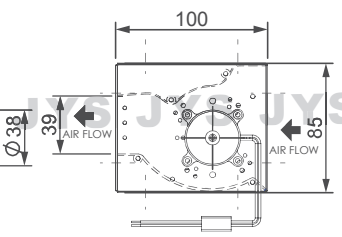
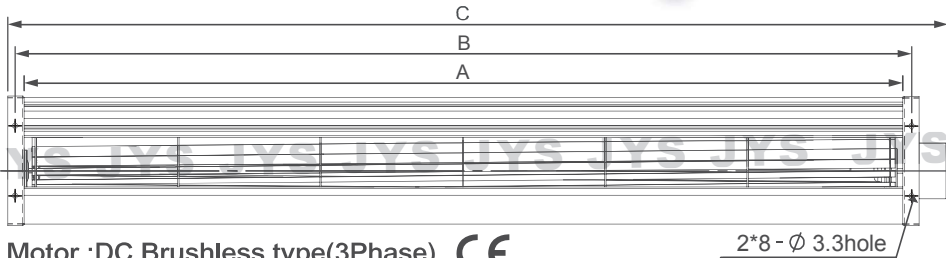
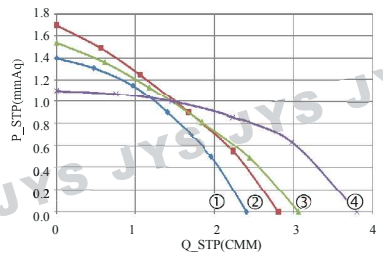

Motor :DC Brushless type(3Phase) **CE**

Model	Spec.	Size(mm)			Rated Voltage (DC V)	Rated Current (A)	Speed (r.p.m.)	Max Pressure (mmAq)	Maximun Air Flow (m³/min)	Noise dB(A)	Weight (g)
		A	B	C							
JM3-06030A24-3B	①	310	325	355	24	0.23	1900	1.4	2.4	34	700
JM3-06036A24-3B	②	370	385	455		0.25	1850	1.7	2.8	33	770
JM3-06042A24-3B	③	430	445	475		0.27	1750	1.5	3.1	32	840
JM3-06060A24-3B	④	610	625	655		0.30	1550	1.1	3.8	31	900



# JE3-060/JG3-060A SERIES DC FAN



(Single Blower)

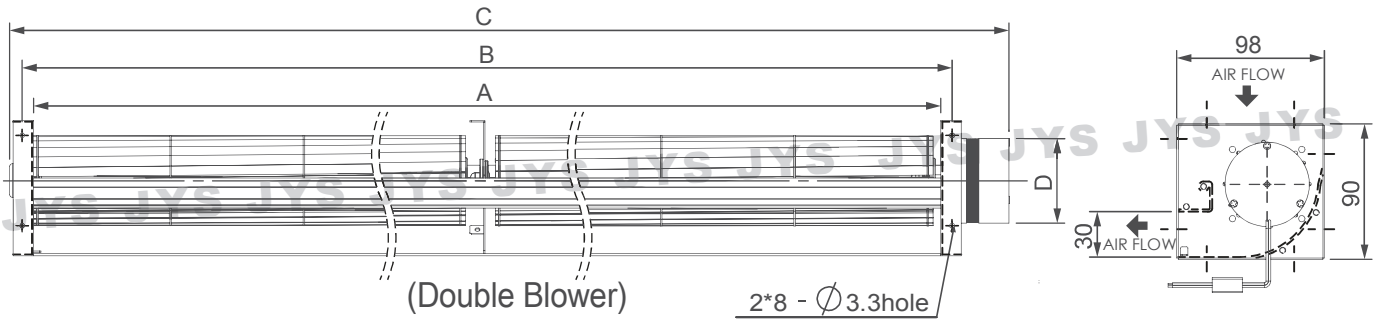

(Double Blower)

Motor :DC Brushless type(3Phase) **CE**

※ ○ : Single Blower ◎ : Double Blower

Model	Spec.	Size(mm)				Rated Voltage (DC V)	Rated Current (A)	Speed (r.p.m.)	Max Pressure (mmAq)	Maximun Air Flow (m³/min)	Noise dB(A)	Weight (g)	Blower
		A	B	C	D								
JE3-06012A24-3B	①	124	139	168	38	24	0.35	2500	4.4	1.9	44	500	○
JE3-06018A24-3B	②	184	199	228	38		0.40	2200	3.2	2.5	42	580	○
JE3-06024A24-3B	③	245	260	305	56		0.42	2100	3.6	3.3	41	850	○
JE3-06030A24-3B	④	305	320	365	56		0.46	2000	3.5	4.1	41	930	○
JE3-06036A24-3B	⑤	365	380	425	56		0.51	1950	3.4	4.7	40	1000	○
JE3-06042A24-3B	⑥	425	440	485	56		0.53	1900	3.3	5.3	40	1080	○
JG3-06060A24-3B	⑦	610	625	670	56		0.63	1650	2.5	6.9	39	1250	○
JG3-6036X2A24-3B	⑧	750	765	810	56		0.69	1700	2.6	7.7	40	1420	◎
JG3-6042X2A24-3B	⑨	870	885	930	56		0.78	1600	2.5	8.3	41	1550	◎

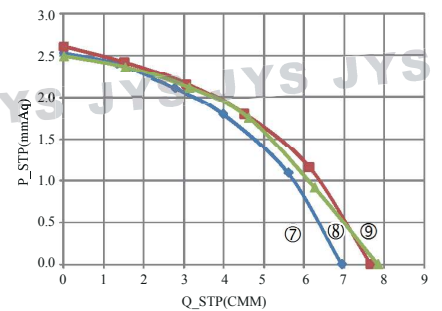
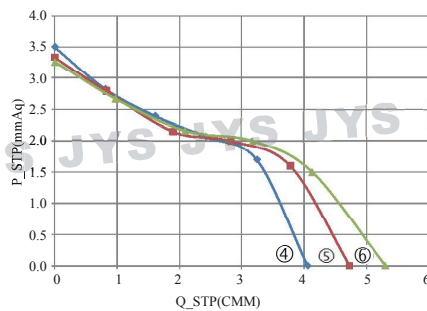
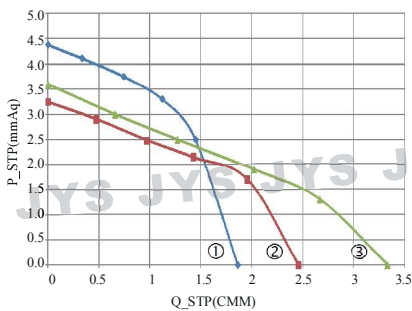



# JE3-060B SERIES DC FAN

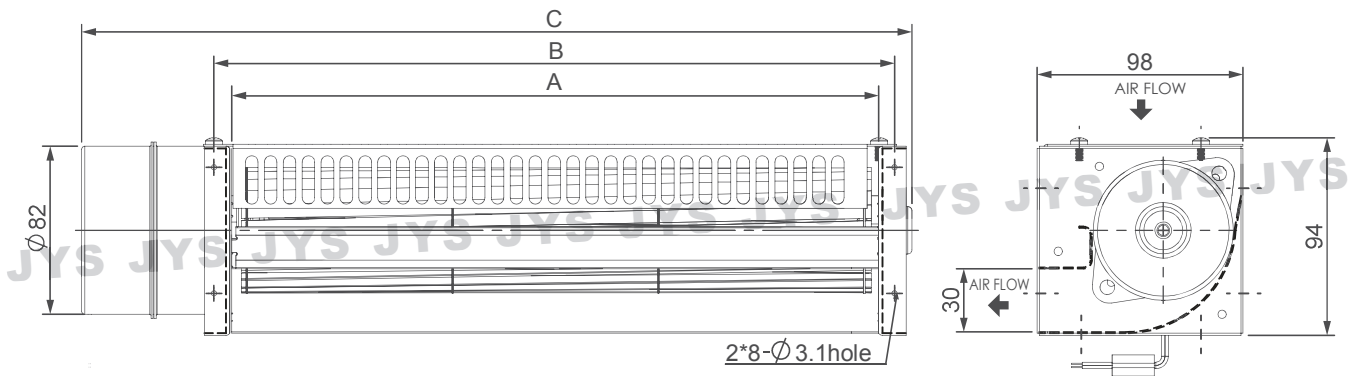

Motor :DC Brushless type(3Phase)

Model	Spec.	Size(mm)			Rated Voltage (DC V)	Rated Current (A)	Speed (r.p.m.)	Max Pressure (mmAq)	Maximun Air Flow (m <sup>3</sup> /min)	Noise dB(A)	Weight (kg)
		A	B	C							
JE3-06030B24-3B	①	306	321	375	24	2.3	3500	10.0	7.5	62	1.4
JE3-06030B48-3B	②	306	321	375	48	1.0	3500	10.0	7.5	62	1.4
JE3-06036B48-3B	③	368	383	469	48	1.1	3300	8.6	8.2	60	1.6
JE3-06042B48-3B	④	406	444	530	48	1.1	3150	8.1	9.3	60	1.8

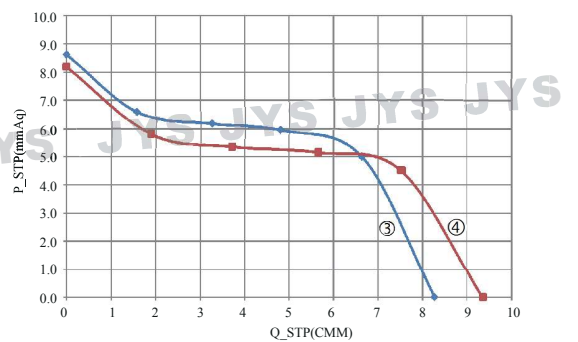
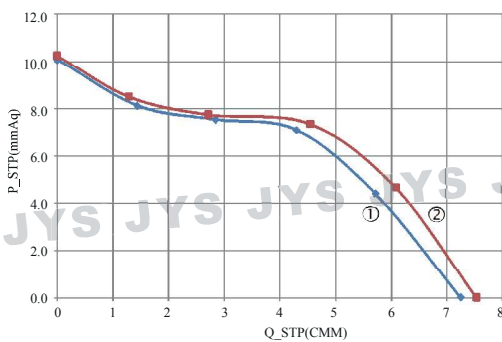

# JQF3-060A SERIES DC FAN

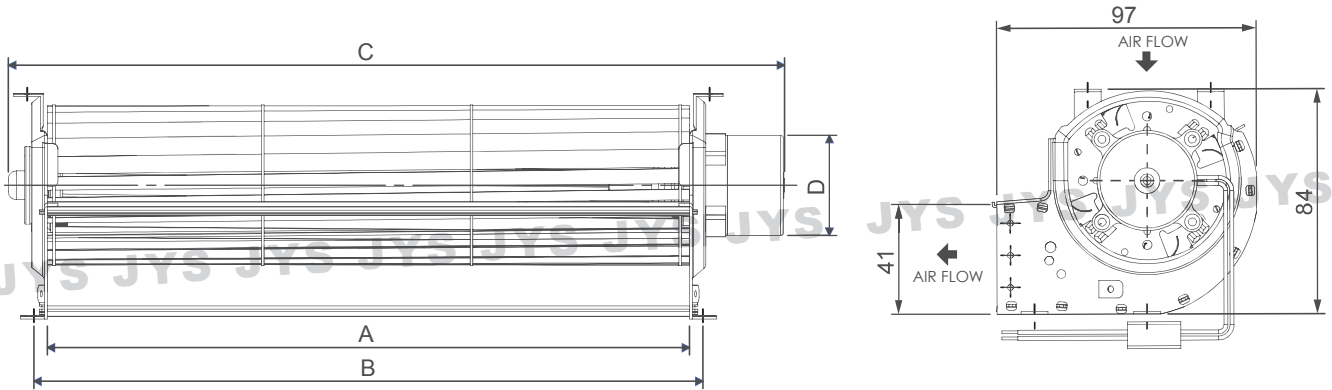

Motor :DC Brushless type(3Phase) **CE**

Model	Spec.	Size(mm)				Rated Voltage (DC V)	Rated Current (A)	Speed (r.p.m.)	Max Pressure (mmAq)	Maximun Air Flow (m³/min)	Noise dB(A)	Weight (g)
		A	B	C	D							
JQF3-06012A24-3B	①	120	130	180	38	24	0.24	2000	6.4	1.8	39	400
JQF3-06018A24-3B	②	180	190	240	38		0.28	1600	4.6	2.2	36	570
JQF3-06024A24-3B	③	240	250	308	56		0.51	2000	6.1	3.9	44	790
JQF3-06030A24-3B	④	300	310	368	56		0.59	1850	5.5	4.7	45	860
JQF3-06036A24-3B	⑤	360	370	428	56		0.66	1750	5.3	5.6	47	950

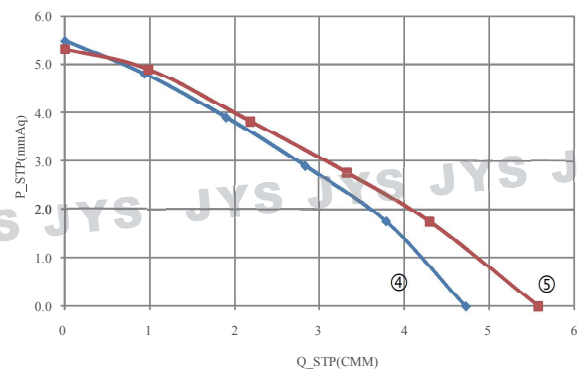
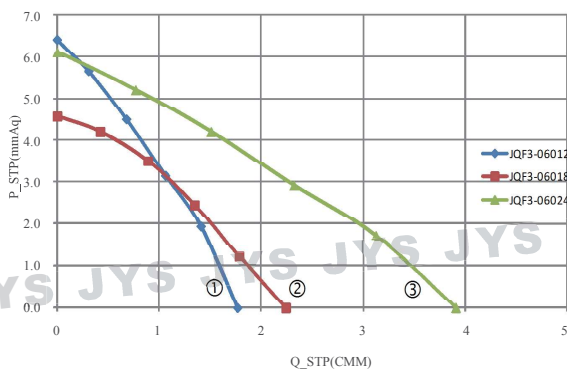



# JQ3-065A SERIES DC FAN

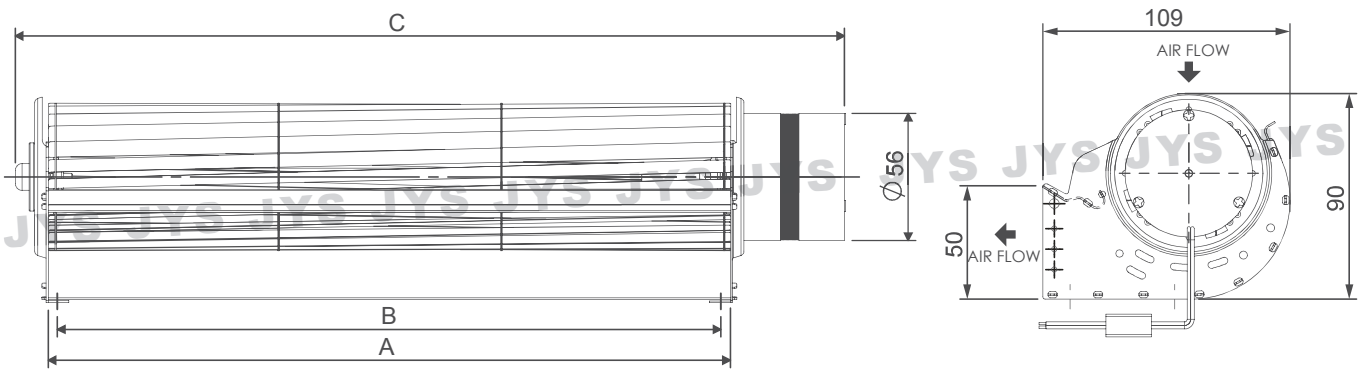

Motor :DC Brushless type(3Phase)

Model	Spec.	Size(mm)			Rated Voltage (DC V)	Rated Current (A)	Speed (r.p.m.)	Max Pressure (mmAq)	Maximun Air Flow (m³/min)	Noise dB(A)	Weight (g)
		A	B	C							
JQ3-06518A24-3B ①		180	172	250	24	0.20	1400	2.8	2.2	34	740
JQ3-06524A24-3B ②		240	232	310		0.23	1300	2.7	2.9	35	810
JQ3-06530A24-3B ③		300	292	370		0.27	1250	2.6	3.8	36	930
JQ3-06536A24-3B ④		360	352	430		0.29	1200	2.4	4.4	38	1050
JQ3-06542A24-3B ⑤		420	412	490		0.32	1150	2.3	5.1	37	1110

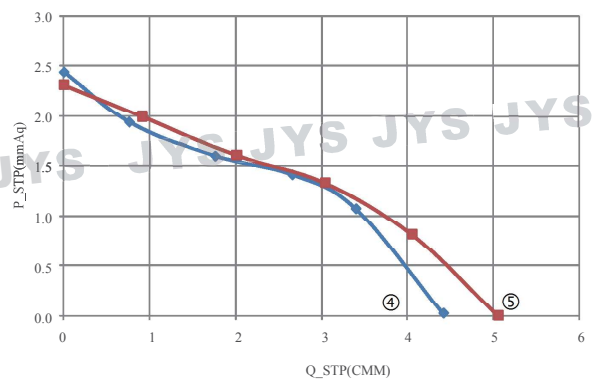
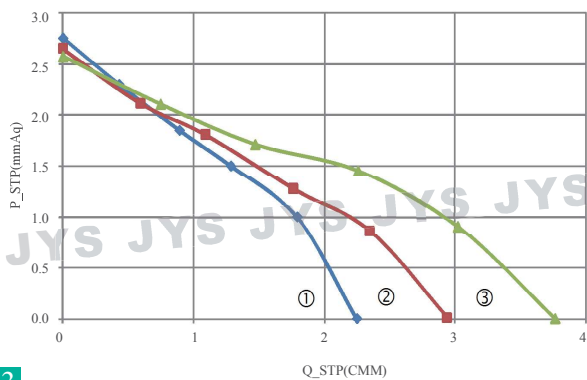

## JF3-065A SERIES DC FAN



(Single Blower)

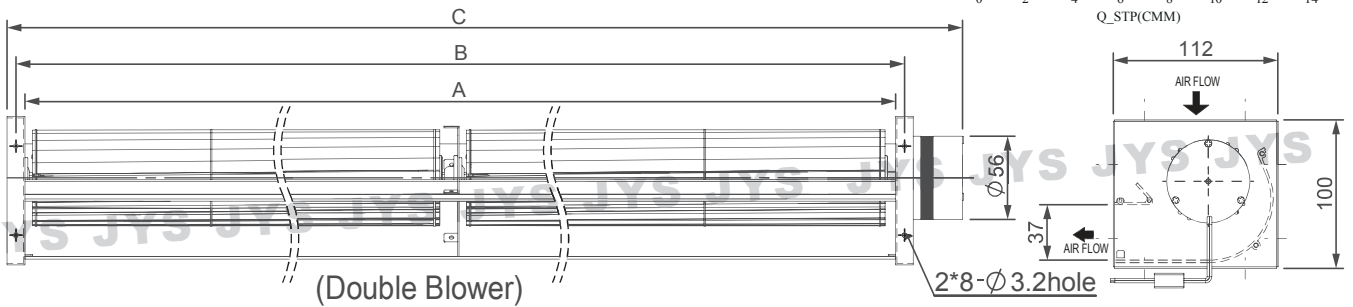
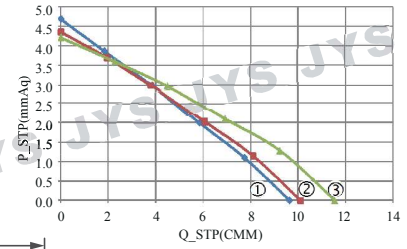

(Double Blower)

Motor :DC Brushless type(3Phase)

※ ○ : Single Blower ◎ : Double Blower

Model	Spec.	Size(mm)			Rated Voltage (DC V)	Rated Current (A)	Speed (r.p.m.)	Max Pressure (mmAq)	Maximun Air Flow (m <sup>3</sup> /min)	Noise dB(A)	Weight (kg)	Blower
		A	B	C								
JF3-06560A24-3B	①	610	622	692	24	0.89	1750	4.7	9.6	48	1.45	○
JF3-6536X2A24-3B	②	750	762	832		0.93	1650	4.4	10.1	47	1.65	◎
JF3-6542X2A24-3B	③	870	882	952		1.02	1550	4.2	11.5	46	1.80	◎

## JH3-081A SERIES DC FAN

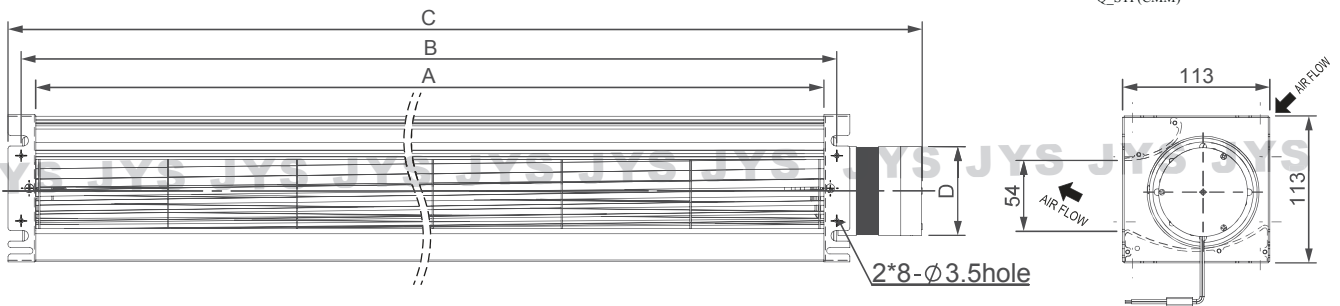
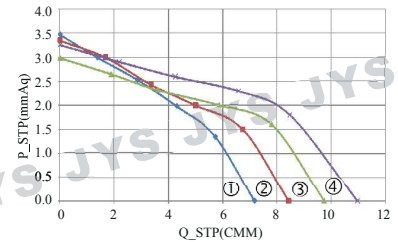

Motor :DC Brushless type(3Phase)

Model	Spec.	Size(mm)				Rated Voltage (DC V)	Rated Current (A)	Speed (r.p.m.)	Max Pressure (mmAq)	Maximun Air Flow (m <sup>3</sup> /min)	Noise dB(A)	Weight (kg)
		A	B	C	D							
JH3-08142A24-3B	①	420	440	507	56	24	1.55	1850	3.5	7.2	51	1.65
JH3-08150A24-3B	②	500	520	587	56		1.75	1700	3.4	8.4	48	1.80
JH3-08160A24-3B	③	600	620	687	56		1.85	1600	3.0	9.7	46	1.95
JH3-08170A24-3B	④	700	720	790	82		2.10	1700	3.3	11.0	48	2.60





# JF3-081A SERIES DC FAN

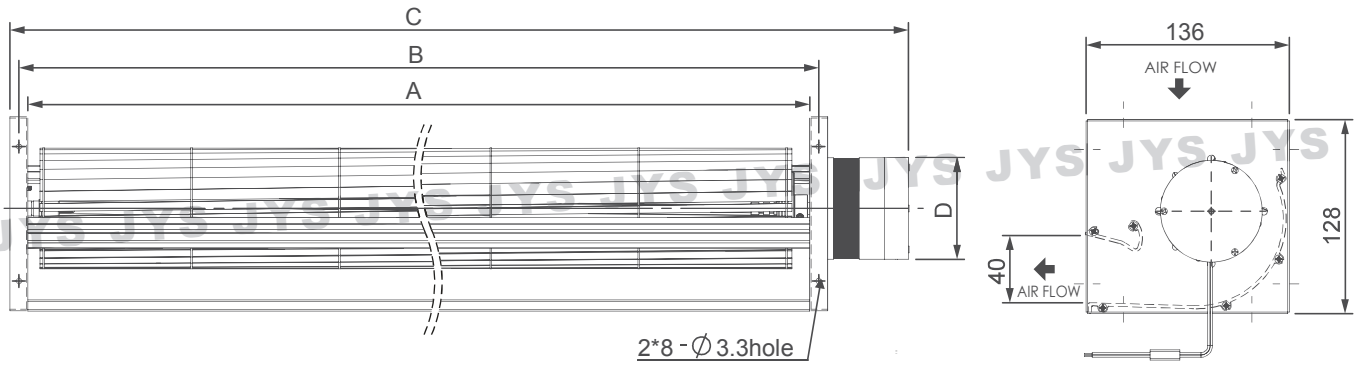

Motor :DC Brushless type(3Phase)

Model	Spec.	Size(mm)				Rated Voltage (DC V)	Rated Current (A)	Speed (r.p.m.)	Max Pressure (mmAq)	Maximun Air Flow (m³/min)	Noise dB(A)	Weight (kg)
		A	B	C	D							
JF3-08142A24-3B	①	440	445	527	56	24	1.85	1650	6.2	10.4	53	1.90
JF3-08150A24-3B	②	520	535	607	56		1.95	1500	5.8	11.7	52	2.05
JF3-08160A24-3B	③	620	635	707	56		2.10	1400	5.5	13.2	51	2.25
JF3-08170A24-3B	④	720	735	805	82		2.30	1500	5.8	16.7	52	2.90
JF3-08180A24-3B	⑤	820	835	905	82		2.35	1400	5.5	18.3	51	3.05

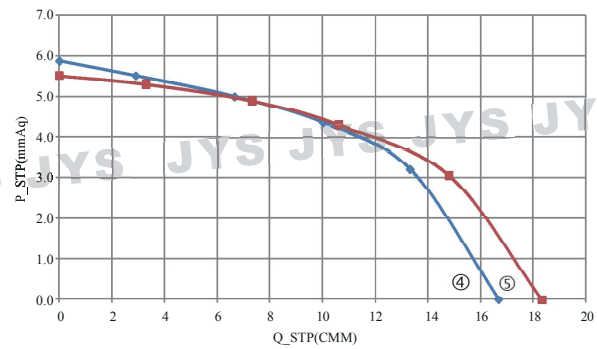
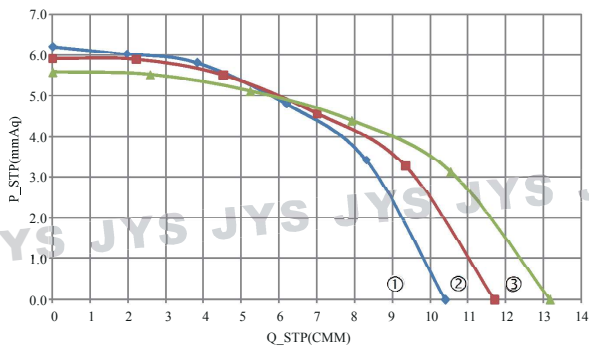

# JAC-110 SERIES AC AIR CURTAIN

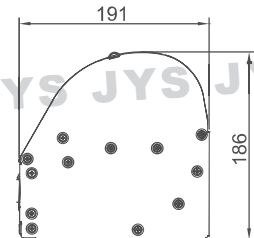
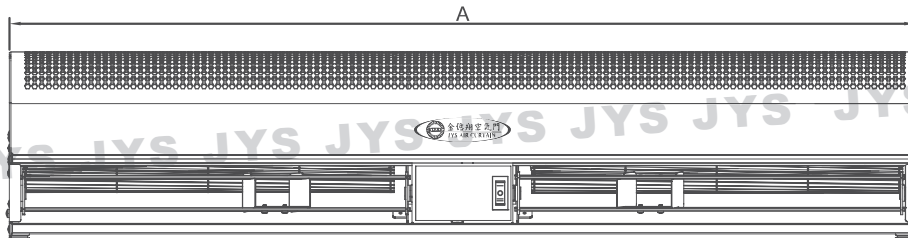

Spec. Model	size (mm)	Speed	Rated Voltage (V)	Rated Frequency (Hz)	Rated Current (A)	Input Power (W)	Air Speed (r.p.m.)	Effective Distance (m)	Maximum Air Flow (m <sup>3</sup> /min)	Noise dB(A)	Weight (kg)
	A										
JAC-1103-11	900	HI/LOW	1Ø-110	60	1.18/0.92	128/102	11.5/9.5	3.5/3.0	33/28	57/53	8.5
JAC-1103-22	900	HI/LOW	1Ø-220	60	0.60/0.47	131/101	11.5/9.5	3.5/3.0	33/28	57/53	8.5
JAC-1103-23	900	HI/LOW	1Ø-230	50	0.54/0.40	120/92	11.5/9.5	3.5/3.0	33/28	57/53	8.5
JAC-1104-11	1200	HI/LOW	1Ø-110	60	1.72/1.34	190/150	11.5/9.5	3.5/3.0	44/37	59/55	10.5
JAC-1104-22	1200	HI/LOW	1Ø-220	60	0.85/0.67	191/148	11.5/9.5	3.5/3.0	44/37	59/55	10.5
JAC-1104-23	1200	HI/LOW	1Ø-230	50	0.74/0.61	170/140	11.5/9.5	3.5/3.0	44/37	59/55	10.5
JAC-1105-11	1500	HI/LOW	1Ø-110	60	2.24/1.62	242/180	11.5/9.5	3.5/3.0	55/46	60/56	12.5
JAC-1105-22	1500	HI/LOW	1Ø-220	60	1.16/0.87	257/195	11.5/9.5	3.5/3.0	55/46	60/56	12.5
JAC-1105-23	1500	HI/LOW	1Ø-230	50	0.91/0.73	215/175	11.5/9.5	3.5/3.0	55/46	60/56	12.5

## 適用場所 (APPLICABLE FILEDS) :

### 公共娛樂場所

各大車站、百貨公司、商店、電影院、歌舞廳、咖啡廳、大餐廳、大飯店、大酒店、大旅社、飲食店、食品店、冰果店、理髮廳、美容院、醫院、療養院、辦公大樓、銀行金融界、保險公司、公司行號、學校實驗室、圖書館、會議室、電腦室等。

### PUBLIC AND ENTERTAINMENT AREA

Big Supermarket, Shop, Boutique, Restaurant, Office, School, Waiting Room, Hotel, Hospital, Library, Museum, Meeting Room, Clinic, Department store, Bank, Computer room, Bus station, Food court, etc.



# JAC-110H SERIES AC AIR CURTAIN

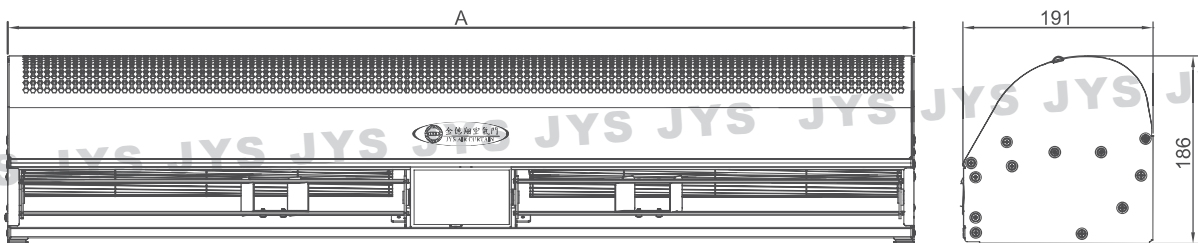

Model	Spec.	size (mm)	Rated Voltage (V)	Rated Frequency (Hz)	Rated Current (A)	Input Power (W)	Air Speed (m/s)	Effective Distance (m)	Maximum Air Flow (m <sup>3</sup> /min)	Noise dB(A)	Weight (kg)
		A									
JAC-1103-11H		900	1Ø-110	60	1.60	177	13.3	4.0	38	61	8.5
JAC-1103-22H		900	1Ø-220	60	0.80	175	13.3	4.0	38	61	8.5
JAC-1104-11H		1200	1Ø-110	60	2.23	240	13.3	4.0	51	63	10.5
JAC-1104-22H		1200	1Ø-220	60	1.10	245	13.3	4.0	51	63	10.5
JAC-1105-11H		1500	1Ø-110	60	3.00	338	13.3	4.0	64	65	12.5
JAC-1105-22H		1500	1Ø-220	60	1.42	320	13.3	4.0	64	65	12.5

## 適用場所 (APPLICABLE FILEDS) :

### ■ 生產工廠

各種裝設有冷暖氣之工廠、試驗室、製藥廠、化工廠、食品加工廠、食品冷凍廠、製冰廠、紡織廠、鑄造廠、電機廠、精密加工廠、塗裝工廠、農業倉庫、下水處理廠等。

### ■ 住宅別墅

一般住宅、公寓、別墅等。

### ■ FACTORY

Especially for all factory with cold and warm air facilities, Electronics factory, Textile Industry, Laboratory, Frozen factory, Chemical factory, Paint Factory, Packinghouse, Circulating & Exchanging Fresh air in sewerage, Field storage, etc.

### ■ HOUSE AND COTTAGE

House, Apartment building, Cottage, etc.

# INTEGRATION INSTRUCTION

## ★機器組裝時注意事項

X表示錯誤之組裝方式 ○表示正確之組裝方式

<p>熱交換器等</p>		
		<p>⑤</p>
		<p>⑦</p> <p>● 斜線部份為所須空間          BLIQUE LINEPCRTION FOR MINIMIZE INSTALLATION SPACE</p>